



The GEN IV Gas Cooled Fast Reactor: Status of Studies



J. Rouault (CEA Cadarache)

T. Y. C. Wei (ANL)

ARWIF-2005

Feb. 16, 2005



Rationale for GFR



Pioneering Science and Technology

- **Gas Cooled Fast Reactors (GFRs) share the positive attributes of fast reactors**
 - Neutronic flexibility (burning, breeding)
 - Sustainable fuel cycle
 - High fuel utilization

- **Use of helium coolant makes them even more attractive**
 - Ease of in service inspection
 - Chemically inert
 - Potential for high temperatures
 - *possibilities for new applications of nuclear energy, including hydrogen production.*
 - *high thermal efficiency*
 - Potential for direct cycles.
 - Low activation and neutron transparency

- **GFRs are a strong candidate for Gen IV systems**

- **CEA of France and the U.S. have started a dual R&D/design effort**



I-NERI Project Organization



Pioneering Science and Technology

- **CEA Laboratory/** Commissariat à l'Énergie Atomique (CEA)
- Principal Investigator:** Cadarache/J. Rouault
- **DOE Laboratory/** Argonne National Laboratory (ANL)/
- Principal Investigator:** T. Y. C. Wei
- **France Collaborating Organization:** CEA-Saclay
CEA-Grenoble
FRAMATOME/ANP
- **U.S. Collaborating Organization(s):** Brookhaven National Laboratory (BNL)
Oak Ridge National Laboratory (ORNL)
General Atomic Company (GA)
Massachusetts Institute of Technology (MIT)
- **Project Start Date:** March 2002
- **Project Duration:** Three years
- **Scope of Work:** Generation IV Nuclear Energy Systems GFR



The GEN IV GFR



Pioneering Science and Technology

It is a closed fuel cycle Fast spectrum system

- complementary approach to liquid metal cooling (SFR)
- integral recycling of all actinides
- self-sustainable cores

It is a high temperature reactor – 850°C – (high efficiency electricity production and co-generation)

- refractory and confining fuel for an increased robustness to severe accidents
- a sustainable version of the VHTR

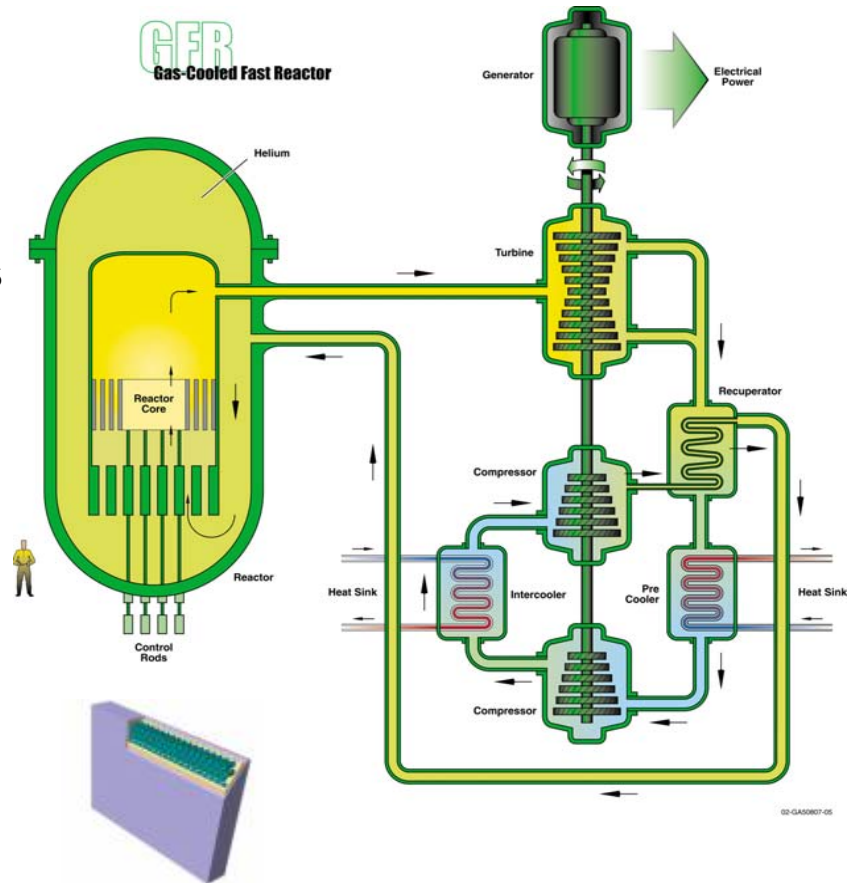

The GFR applies the related GEN IV closed fuel cycle



Pioneering Science and Technology

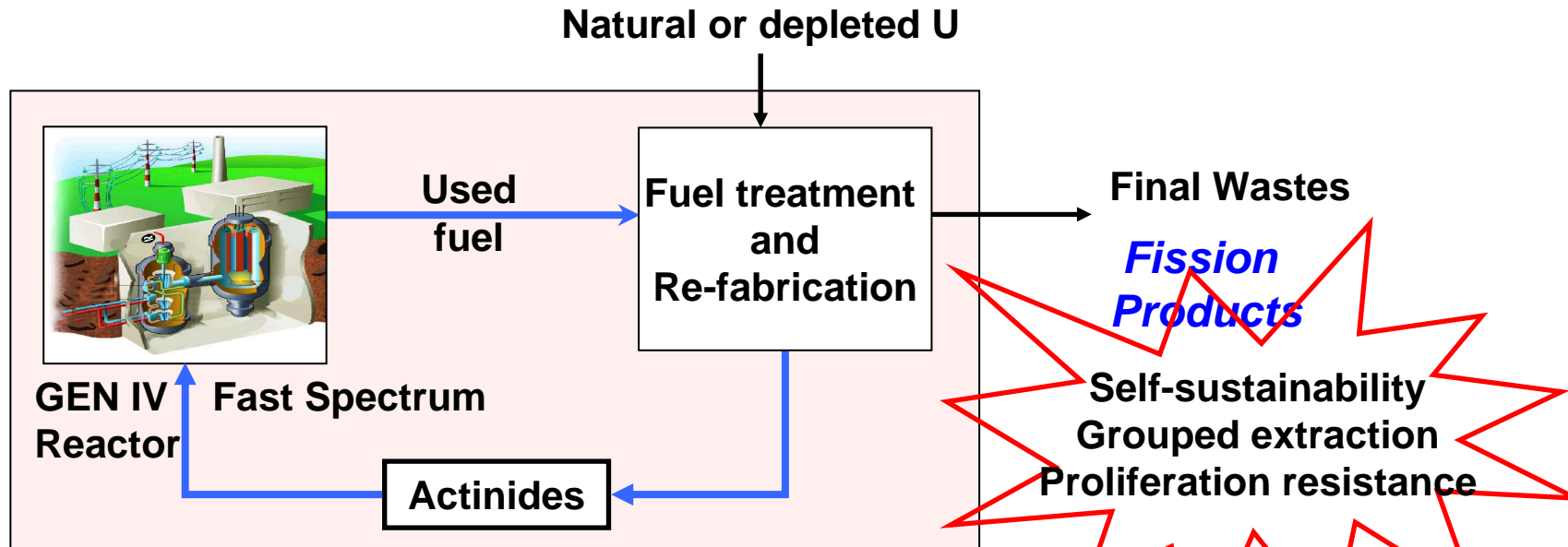

- **Plutonium** is the fissile species
- All the actinides (U, Pu, Np, Am, Cm) are recycled together and not separated (integral actinide recycling)
- The use of fertile sub-assemblies is minimized : search for **self-sustaining cores with a breeding gain close to zero**
- The fuel cycle is only fed by natural or depleted U
- On site integration of fuel treatment and re-fabrication



The GFR objectives



Pioneering Science and Technology

The GFR occupies a particular position within GEN IV systems as :

- a complementary approach to liquid metal cooling for fast spectrum reactors

-a “sustainable” version of the VHTR

To summarize :

→ The GFR is optimized to be compatible with the GEN IV closed fuel cycle (full use of uranium resources – wastes minimization – integral actinide recycling)

Strong impact on core design, fuel and fuel cycle processes : GFR is really a **global system** including the reactor and its fuel cycle

→ The GFR will keep the HTR advantages in mind (refractory core, particle fuel,) and benefit from progress made for the VHTR technology (He technology, high temperature materials, energy conversion...)



GFR Project Objective



Pioneering Science and Technology

- **To Design a Gas cooled Fast Reactor System with**
 - A high level of Safety
 - *Successful decay heat removal under wide range of pressurized and depressurized conditions*
 - *Survive loss of active reactivity shutdown capability without core damage*
 - A Full Recycling of Actinides
 - Highly proliferation resistant (no external blankets, conversion ratio = 1.0, fissile content <20%)
 - Attractive in term of Economics
 - *High thermal efficiency (>45%)*
 - *Direct gas cycle*
 - *Hydrogen as a commercial product*

300 (reference) to 1000 MWe, He (Reference) coolant



GFR Key Feasibility Issues



Pioneering Science and Technology

- **Safety case with low thermal inertia and poor heat transfer properties of coolant**
 - Decay Heat Removal strategy
 - Core Melt Exclusion strategy
- **High temperature refractory and confining fuels**
- **Structural materials for high temperatures and fluences**



The GFR design objectives



Pioneering Science and Technology

GFR Design Parameters	Objectives
Unit power	600 to 3000 MWth
Power Conversion Unit	Direct cycle (reference)
Net efficiency (direct cycle helium)	> 45%
Outlet coolant temperature	850 °C or more
Inlet coolant temperature	< 500°C
Power density	50 to 100 MW/m ³ of core
Core pressure drop	< 1 bar
Breeding/Burning performances	Self-sustaining core
Cycle strategy	Closed fuel cycle with all actinides recycling
Fuel	Refractory fuel (HTR particle fuel is the model)
Indicative maximum fuel temperature	~ 1200°C (nominal operation) ~ 1600 °C (accidental situations)
Fuel management	About two years operation cycle
Fuel burn up	~10 at% (initial goal)



GFR core design : core power density



Pioneering Science and Technology

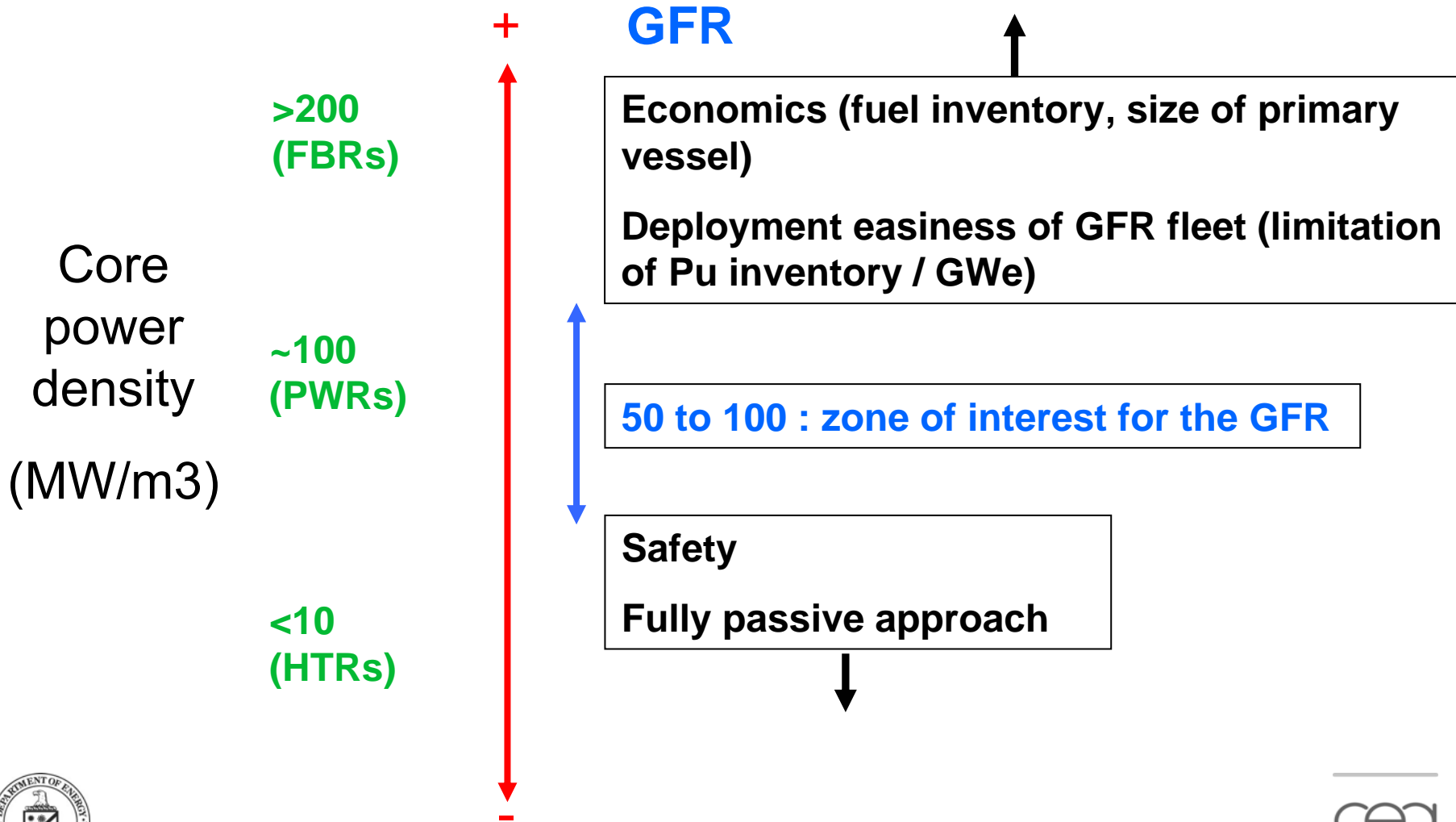

Fuel Cycle Economics



Pioneering Science and Technology

Fuel cycle cost dependence on specific power

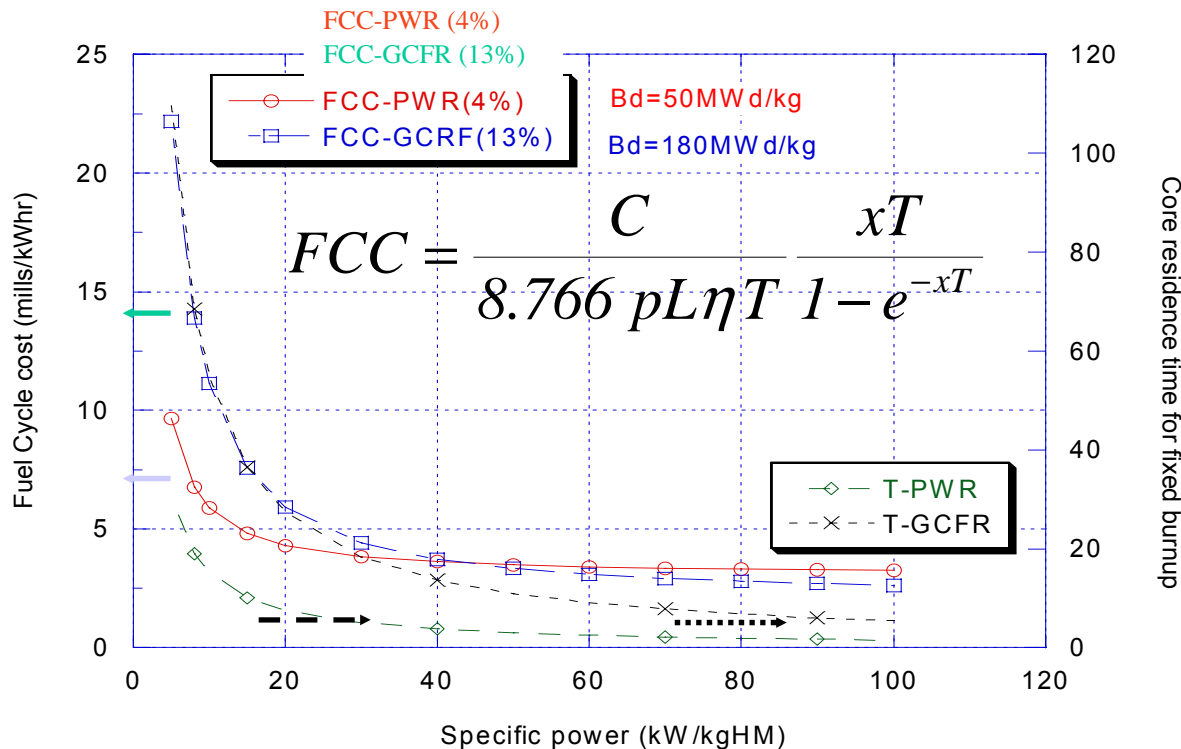

GCFR

- For U235 enriched fuel
- $\eta = 45\%$, $L = 0.90$
- $Bd = 180 \text{ MWd/kgHM}$
- discount rate $x = 10\%/yr$
- $C = 3936 \text{ \$/kg}$ for $e = 13\%$

PWR

- $\eta = 33\%$, $L = 0.90$
- $Bd = 50 \text{ MWd/kgHM}$
- discount rate $x = 10\%/yr$
- $C = 1200 \text{ \$/kg}$ for $e = 4.5\%$
- Fabrication $200 \text{ \$/kg}$
- $SP = 38 \text{ kW/kgHM}$

• Specific power should not be much below 20 MWd/kg , Shoot for 25 kW/kgHM (BWR)



Core design : thermics and thermohydraulics



Pioneering Science and Technology

Limitation of fuel temperatures (nominal conditions : 1200 °C; accidental conditions : 1600 °C) and preserve in any situation of good coolability potential of the core

- thermal conductivity

- margins to melting

 - carbide, nitride (dense fuels)

- reasonable values for the power density

 - 50 - 100 MW/m³

- adequate fuel sub-assembly design

 - 40 à 50% of He coolant

- gas cooling (natural and forced convection)

 - low core pressure drop close to 0.5 bar ...



GFR core design : Core constitution



Pioneering Science and Technology

40 to 50% of core volume occupied by He coolant



10% (provision) occupied by sub-assemblies structures and non-fissile S/As



40 to 50% of core volume available for the fuel



20 to 25% of core volume occupied by actinide compound
(self-sustainable and critical core)

The fuel contains the actinide compound and inert materials acting as barriers against fission product release (if any)

→ The actinide compound must occupy at least in between 50 to 62.5% of the fuel volume



GFR core design : Core constitution



Pioneering Science and Technology

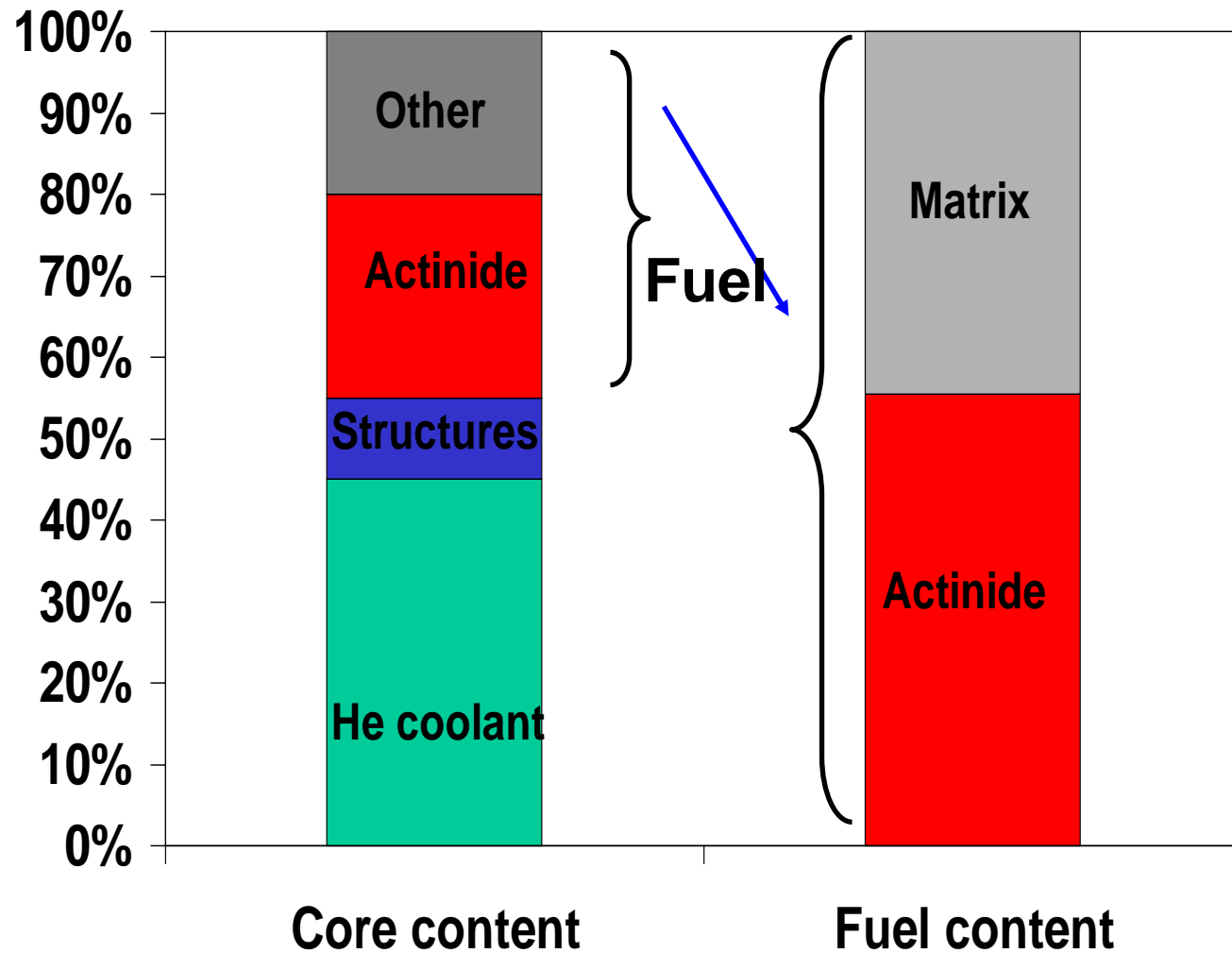

GFR core design : self-sustainable core



Pioneering Science and Technology

→ Candidate dense actinide compounds :

Pu/(U+Pu) = 0.2	Carbide (U,Pu)C	Nitride (U,Pu)N	Oxide (U,Pu)O ₂	Metallic fuel (U,Pu)Zr
Theoretical density (g/cm ³)	13.6	14.3	11	15.6
Heavy atom density (g/cm ³)	12.95	13.53	9.75	14
Melting point (°C)	2420	2780	2430	1080
Thermal conductivity (W/m/°K)	16.5	14.3	2.9	14
Comments	(n,p) reactions on N14 (which generates C14) degrade the nitride fuel performances except if the nitrogen is enriched in N15 (natural nitrogen composition is 99.64% of N14 and 0.36% of N15)			



GFR core design : candidate fuel concepts



Pioneering Science and Technology

2 logics :

Close FP confinement logic + cold fuels : **the HTR model**

- **HTR Particle extrapolation** : needs reduced and challenging values for the particle T/D ratio (0.15 to be compared to 0.3 or more for HTRs)
- **HTR Particle generalization** → **Dispersed fuels** : > 50 % of actinide compound (spheres, fibers) in an inert material (matrix)

Classical logic + higher fuel temperatures

- Fission gas collection in external plenums
- **Pin concepts with a solid solution fuel** allows easily the the required heavy atom content. **High temperature cladding is the challenge**



Core design : possible fuel options



Pioneering Science and Technology

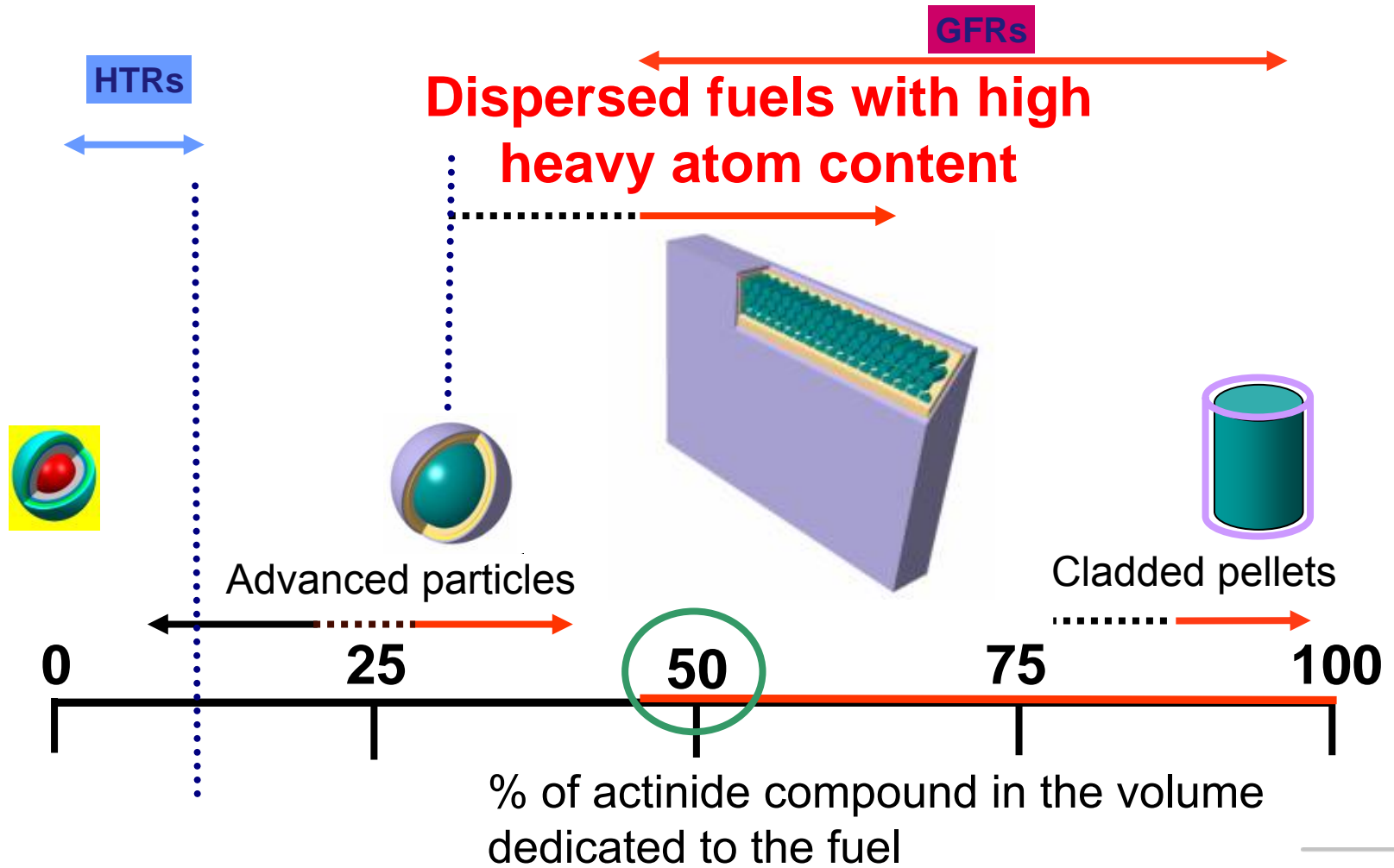

GFR core design : candidate fuel sub-assemblies



Pioneering Science and Technology

Plate-type

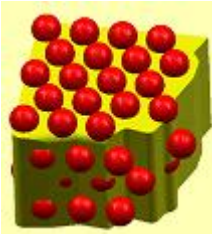
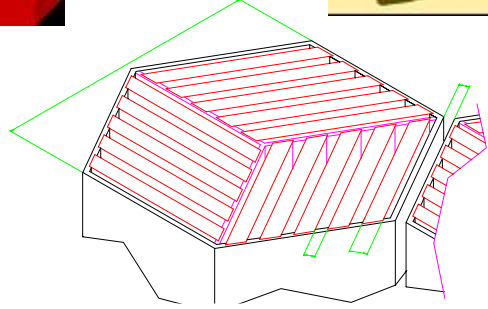

Block-type

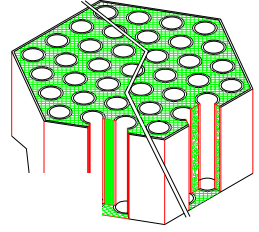
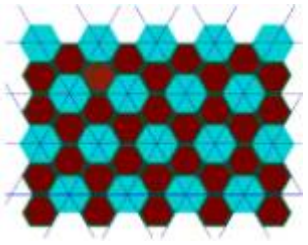
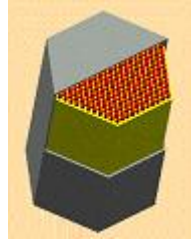

Particle bed

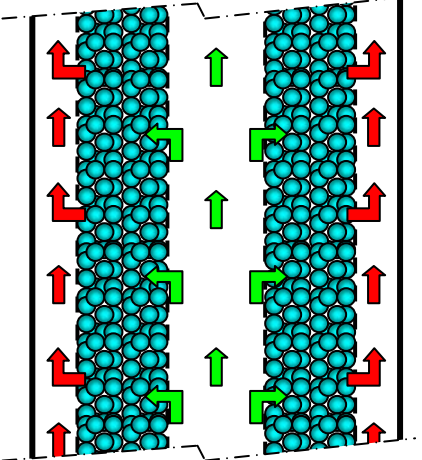

Pin-type

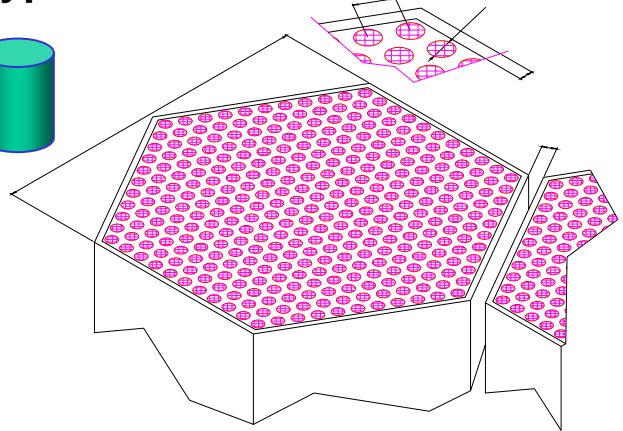
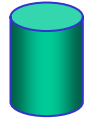

GFR core design : candidate fuel sub-assemblies



Pioneering Science and Technology

→ thermo-mechanical, pressure drop and heavy atom content criteria :

- **plate type sub-assembly is the reference** with carbide (or nitride) fuel and SiC (or other ceramic) as matrix and structural material – close FPs confinement strategy

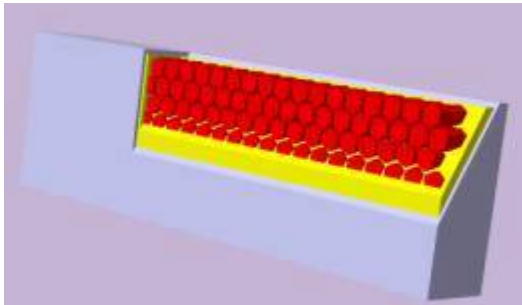

- **pin type sub-assembly is an alternative** with the same materials – FPs collected in a pin plenum

- **particle fuel is not excluded** but hardly compatible with the self-sustainability criteria



Core design : the unit power



Pioneering Science and Technology

→ At a given power density, the unit power determines the core volume :

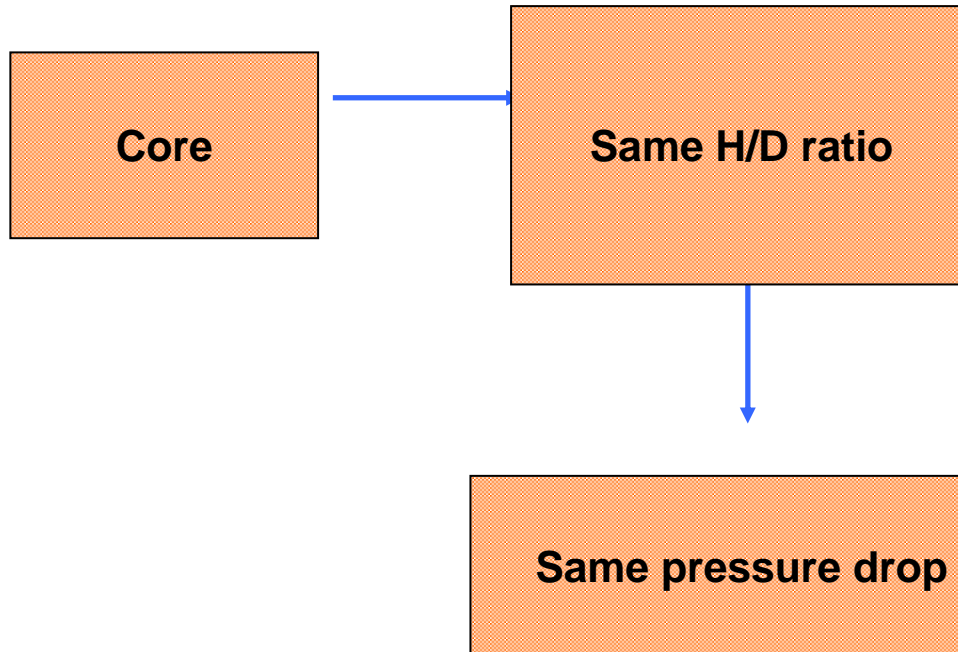

↘ **Neutron leakage**
(favorable to reach BG=0 with a reduced heavy atom content → less challenging fuels)
But ↗ Core pressure drop

↘ Neutron leakage

→ A compromise has to be found but **the unit power increase helps achieving self-sustainability with less challenging fuels**



Core design : the feasibility domain approach



Pioneering Science and Technology

Thermo-aerolics constraints :

- Maximum fuel temperature \rightarrow gives a relation between the hydraulic diameter D_h and the coolant gas fraction $gas\%$ in the core for a given fuel and a given power density
- Core pressure drop \rightarrow gives a maximum value for the H/D function of D_h and $gas\%$, thus on only $gas\%$ (previous relation) for given unit power and power density

$$gas\% + \Delta T \rightarrow D_h + \Delta P \rightarrow H/D$$

Neutronics constraint : self sustainability

\rightarrow Implies a minimum H/D value depending on the fuel volume fraction and thus on the $gas\%$

- Dispersed fuel (50/50, 70/30)
- Pin fuel
- Various materials
- 600 \rightarrow 3000 MWth
- 50 \rightarrow 100 MW/m³

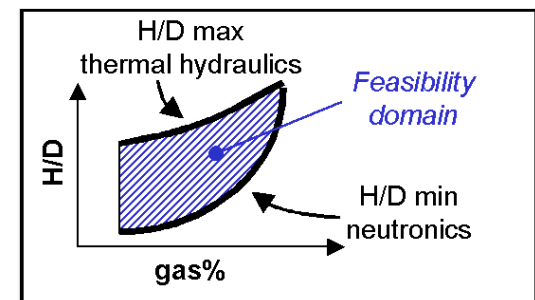
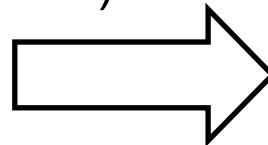

The core design : selection process



Pioneering Science and Technology

➔ No solution at 600 MWth and 100 MW/m³ with a 50/50 dispersed fuel but potential feasibility at 2400 MWth

➔ The feasibility domain decreases when increasing the power density

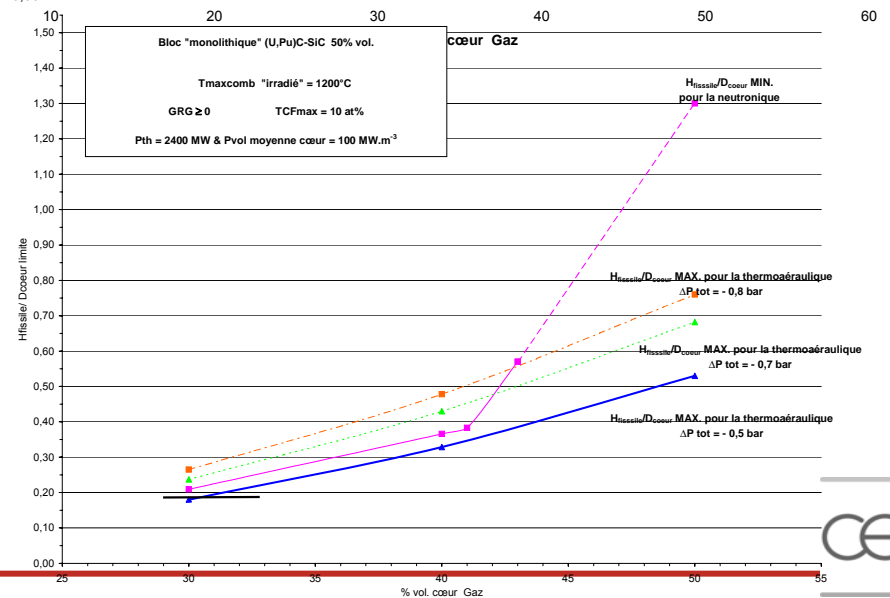
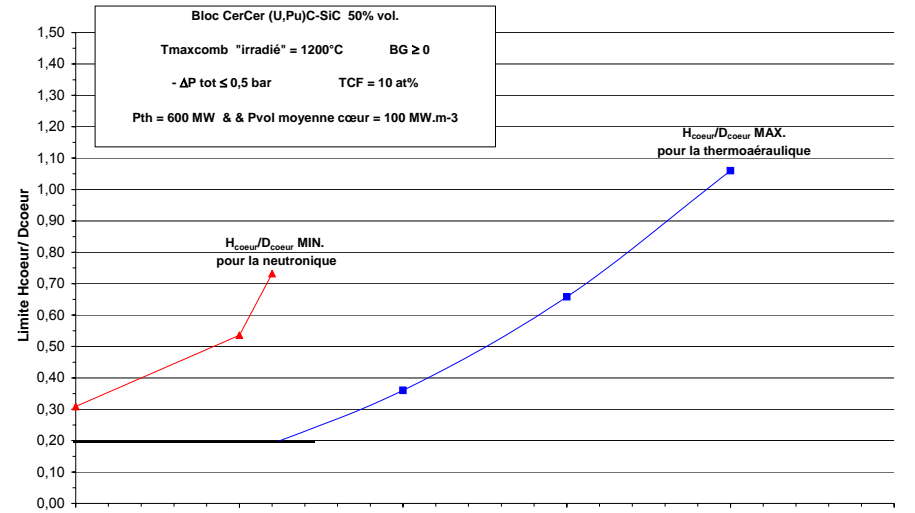
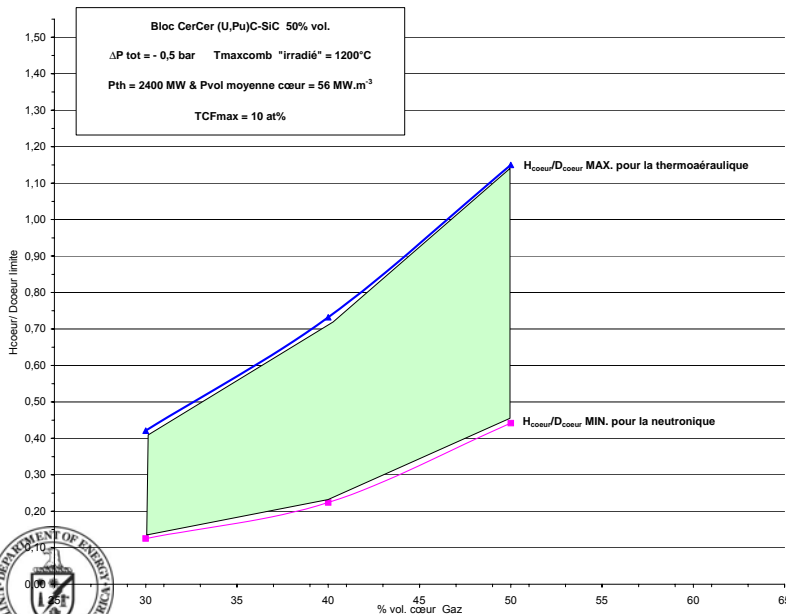

Core design : an example of promising concept



Pioneering Science and Technology

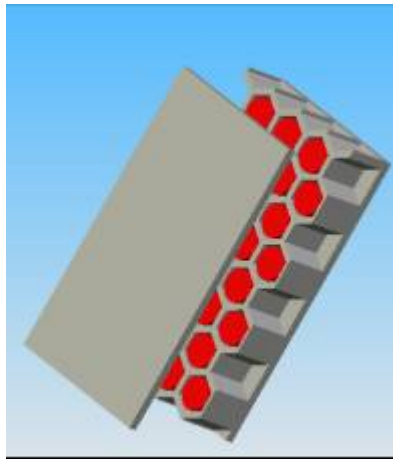
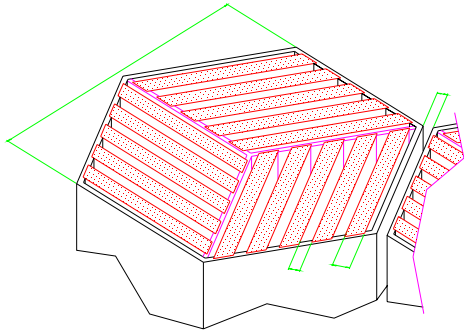

A plate-type fuel sub-assembly :

→ 56/28/16 resp. vol% of fissile/free vol./matrix in the honeycomb

→ Plate closure is made of SiCf-SiC 1 mm thick

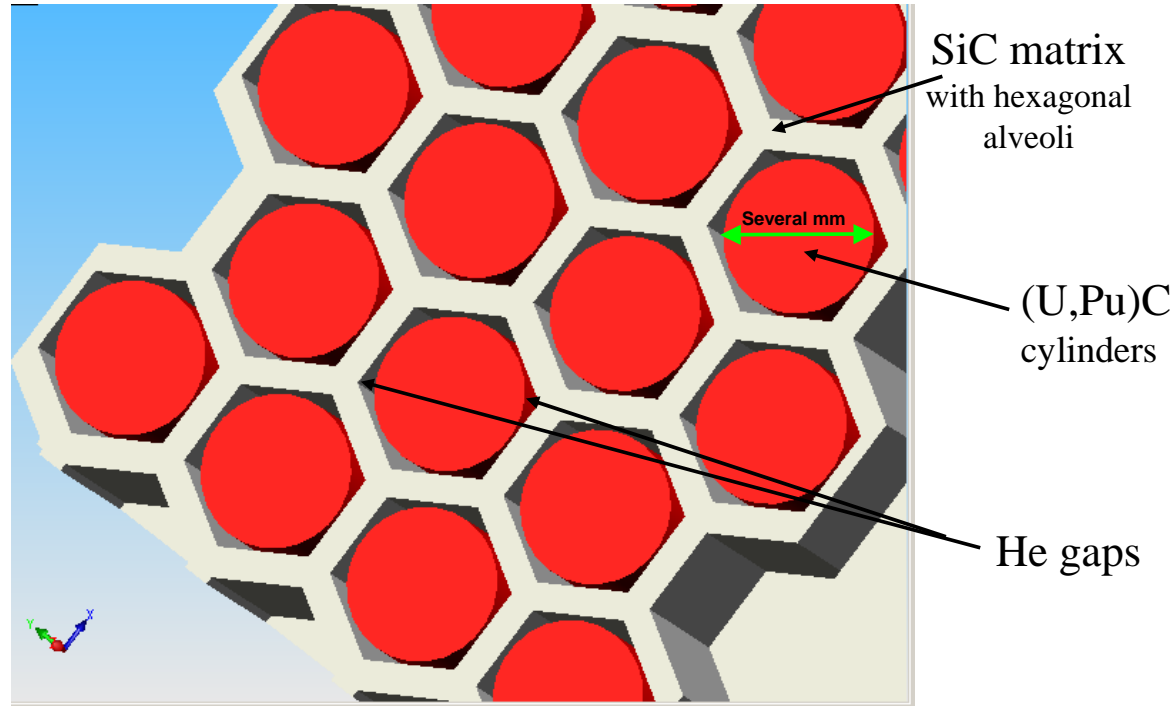

$(U,Pu)C_{56\%vol} - (gaps_{28\%vol} + SiC_{16\%vol})$
He gaps = 1/2 volume of the fissile phase in a first design integration



Possible options for 600 ou 2400 MWth GFRs



Pioneering Science and Technology

Options	Plates of Carbide CERCER (50/50) 1	Carbide pins With SiC cladding 2	Blocks/plates Carbide CERCER (70/30)
Unit power	2400 MWt/h/1158 MWe		600 MWth/275 MWe
Pressure	70 bar		
Power density	100 MW/m ³		103 MW/m ³
Core outlet temperature	850 °C		
Core inlet temperature	480 °C		
Mass flow rate and He speed	1320 kg/s ; 66.4 m/s	1320 kg/s ; 42.4 m/s	330 kg/s ; 60 m/s
Core volume	24 m ³		5.8 m ³
Core pressure drop	0.59 bar	0.49 bar	0.4 bar
Structures/helium/fuel	10, 40 , 50 %	15, 65 , 20	10, 55 , 35
Fuel	CERCER (U,Pu)C SiC (50/50)	(U,Pu)C solid solution and SiC cladding	CERCER (U,Pu)C SiC (70/30)
Max. fuel temperature	1200°C	1500 °C	1135 °C
Heavy atoms mass (Pu + MA mass/GWe)	66 tons (8.7 tons/GWe)	53 tons (6.56 tons/GWe)	16 tons (9.3 tons/Gwe)
Core management	3 X 9260 EFPD	3 X 745 EFPD	3 X 441 EFPD
Burnup (%FIMA)	10 % FIMA	10 % FIMA	5 % FIMA
Reactivity coefficients Doppler/ β / He void (10 ⁻⁵)	-1290/341/+211	-968/352/+554	-1136/367/+356



Typical design solutions for the DHR

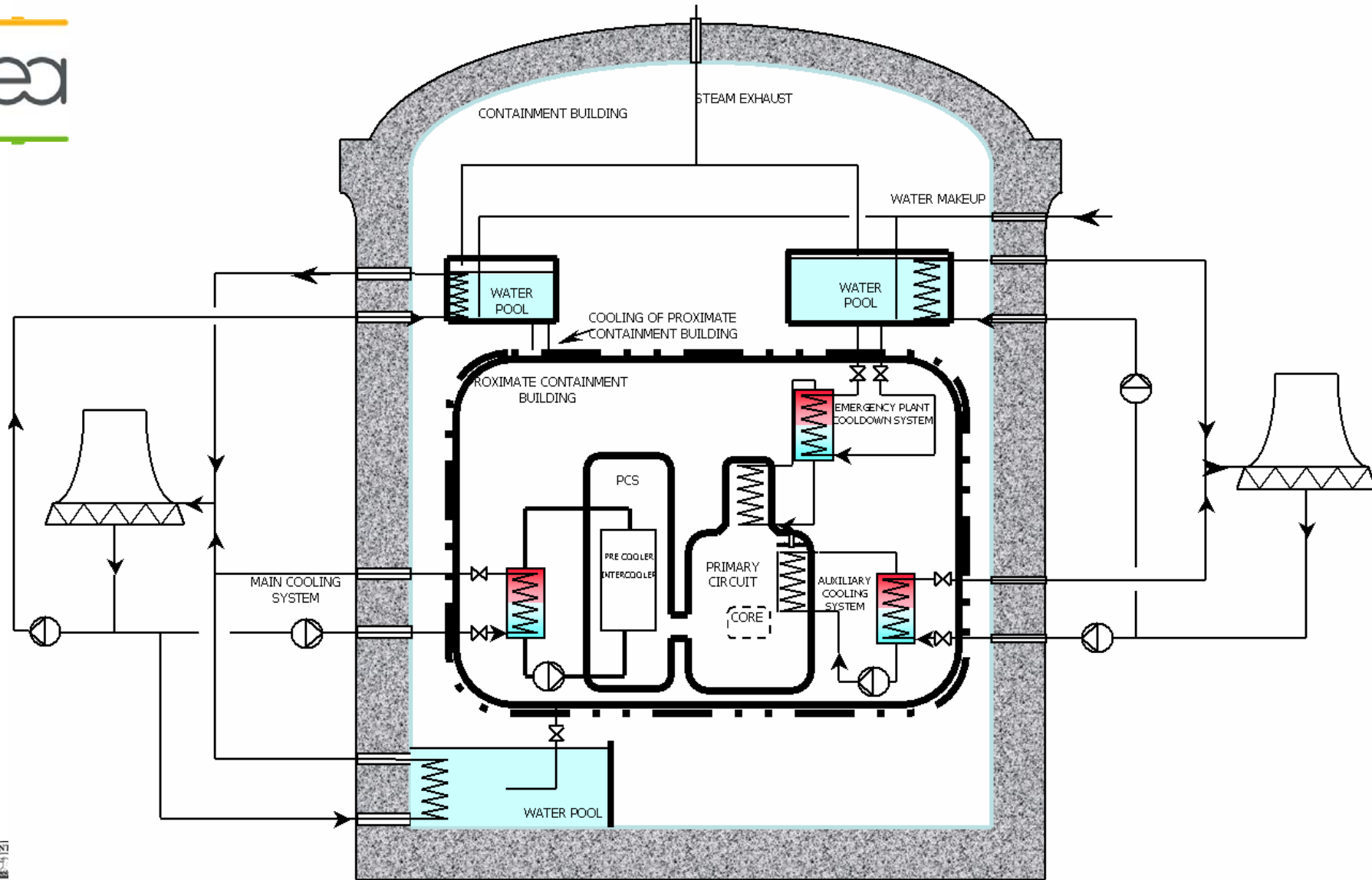

Possible DHR strategies



Pioneering Science and Technology

Strategy 1 : High back-up pressure (>20 bar), use of natural convection only

Strategy 2 : Medium back-up pressure (5 to 7 bar), so low required pumping power (10 kW)

- small active or passive system or energy source for time

- < 24-48 hours,

Then, 2 possibilities,

- + natural convection for time > 24-48 h

- or + recovering of electrical sources for time > 24-48 h

Strategy 3 : Low back-up pressure (1 to 2 bar), so high required pumping power (300 kW) for quite long time, natural convection could be kept for LOFA at high pressure (> 50 bar)

1 means concrete close containment

2-3 could mean classical metallic close-containment



Possible DHR strategies



Pioneering Science and Technology

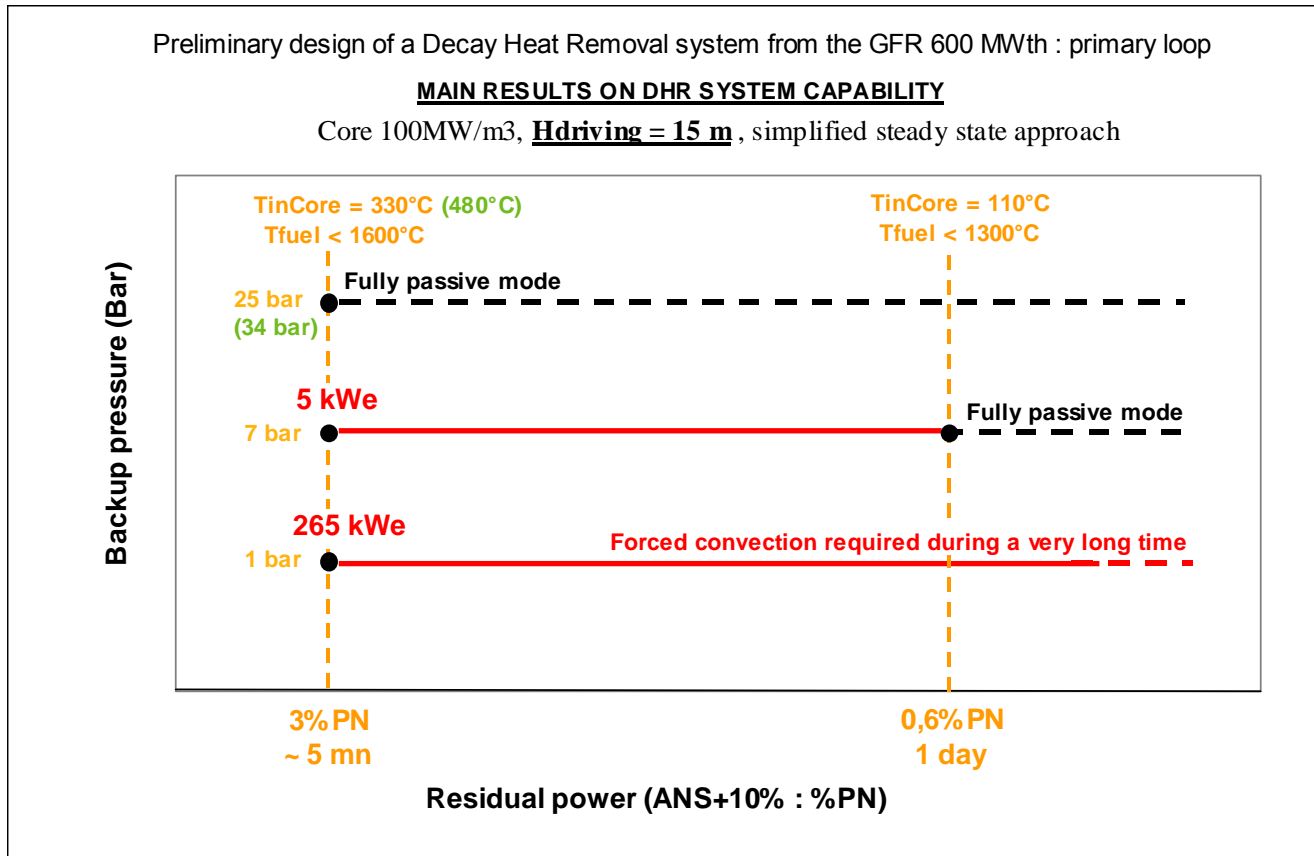

Pumping power varying with $1/\text{Pressure}^2$

- ⇒ High back-up pressure for natural circulation
- ⇒ Medium back-up pressure implies quite low pumping power



A 600 MWth GFR System for DHR Strategy 1



Pioneering Science and Technology

One example of system integration :

→ one concrete proximate confinement with an internal steel liner

→ 3x100% DHR loops in the natural convection equipped with circulators

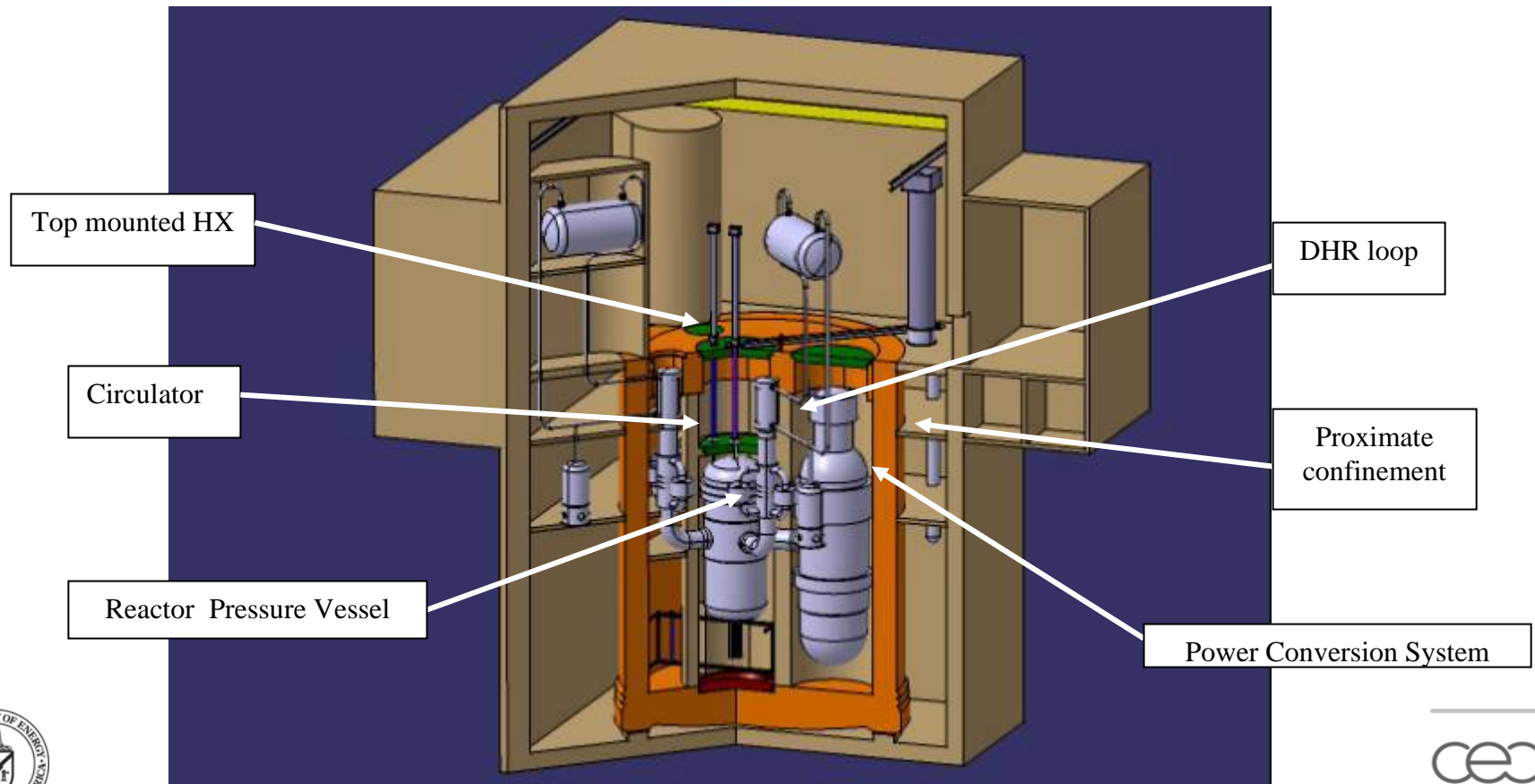

A 600MWth GFR System for DHR Strategy 2



Pioneering Science and Technology

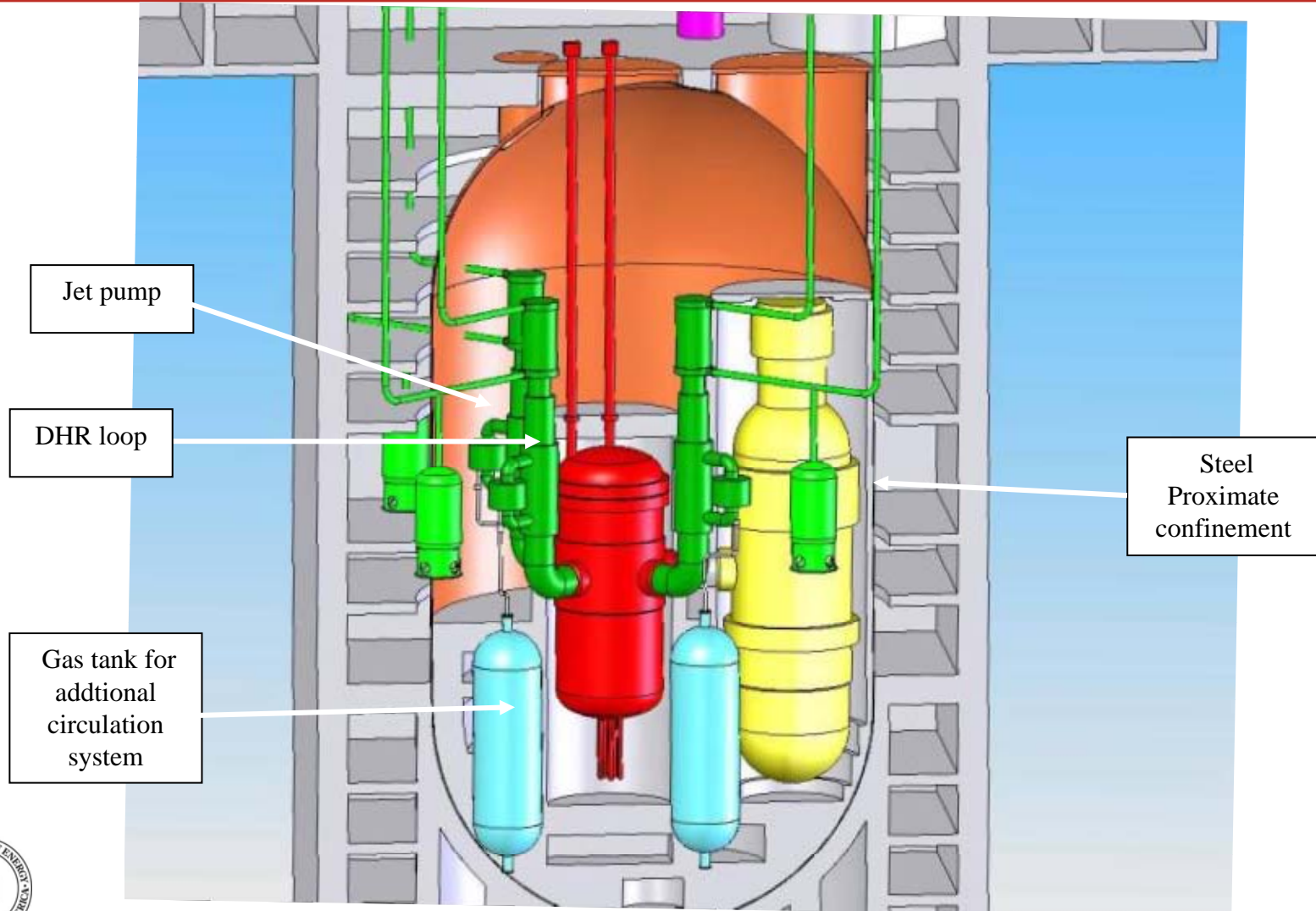

A 2400 MWth GFR system



Pioneering Science and Technology

3 loops, pre-stressed concrete proximate confinement

Star configuration of power conversion units and safety systems

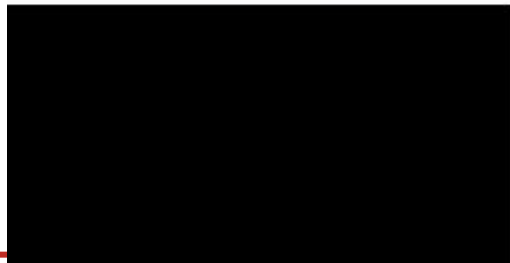
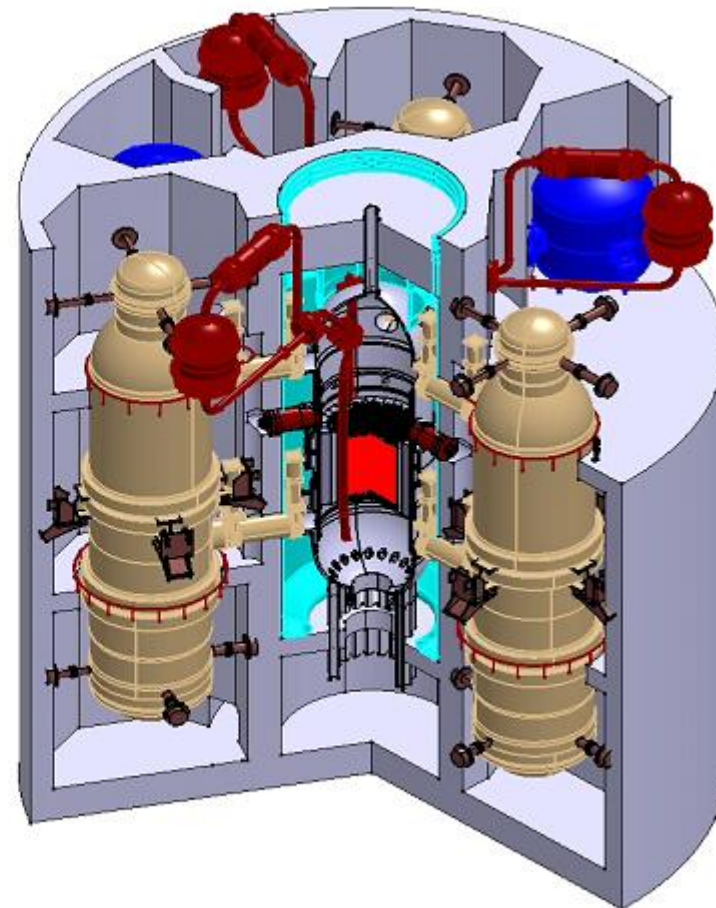
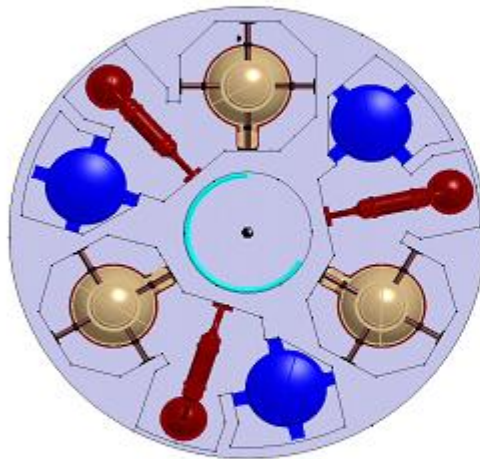
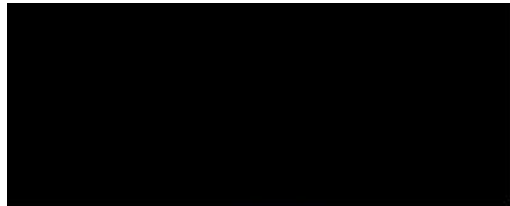

Same trends for reactivity insertion transient

Favourable GFR reactivity effects provides a smooth and friendly “natural” core behavior

- *The level of the void reactivity effect is a safety concern (design objective)*
- *Dispersed fuel using carbide materials are favourable : the very limited spectrum softening enhances the Doppler effect*

The reference is Helium direct Brayton cycle

- efficiency, H₂ production
- synergies with the VHTR (He as primary coolant and direct cycle)

A step toward the reference could be to consider **He at lower temperature as primary and SC CO₂ cycle as secondary**

- margins for the in-core material
- **allow the efficiency aimed at** : reduction of compression work when we are close to the critical point, high fluid density, no risks of water ingress, system compactness
- preserve synergies with the VHTR (He as primary coolant)

Other possibilities of indirect or combined cycles could also be considered

Indirect Cycle for the GFR



Pioneering Science and Technology

Critical point : 7.377 MPa and 30.97 °C

→ One MIT proposal :

Core exit	600 °C
IHX exit	550 °C
Turbine exit	440 °C
Recupérateur 1 exit	168 °C
Recuperator 2 exit	70 °C
Compressor 1 inlet	32 °C
Compressor 1 exit	61 °C
IHX inlet	396 °C
Compressor 2 exit	158 °C

high pressure	200 bar
Low pressure	74 bar

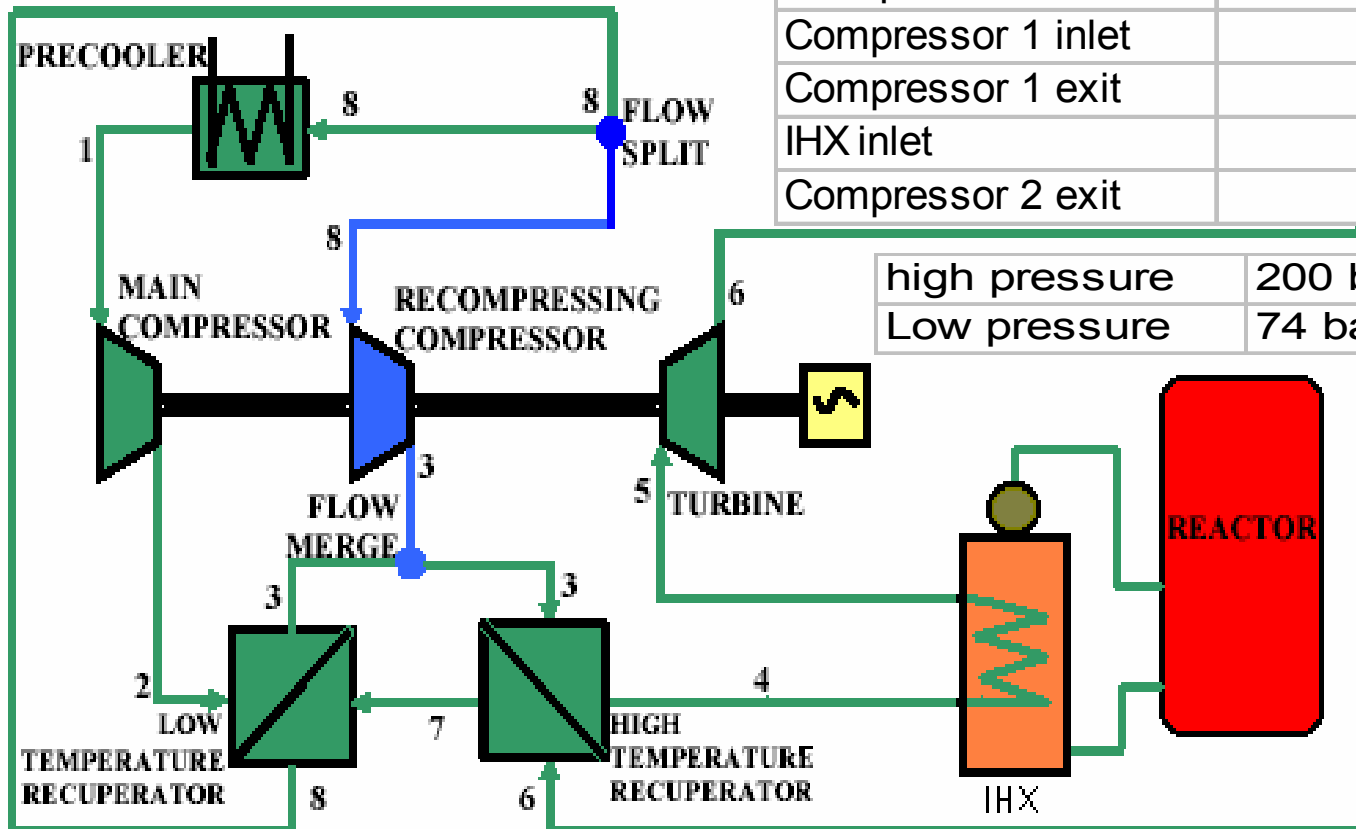

System Studies Status



Pioneering Science and Technology

→ Mainly performed on a 600 MWth GFR

with the **direct energy conversion cycle** (the PCS of the GT-MHR)

- Full characterization of the first DHR strategy
- Preliminary assessment of the second one

+ Some preliminary studies of alternative energy conversion (including indirect cycle with SC CO₂ as secondary coolant) have been performed.

→ **The 2400 MWth** which has advantages considering the core design issue **is the reference for on-going studies**. It will be used to study more open options for the energy conversion and a DHR which must be compatible with a metallic containment (second strategy)



Conclusions



Pioneering Science and Technology

-
- Two main objectives for the GFR in the GEN IV selection
 - A complementary approach to liquid metal cooling for Fast Spectrum systems (ISIR, safety, robust fuel)
 - A sustainable version of the HTR / VHTR

HTR / VHTR → GFR

- Some conclusions et prospects :
 - Confirmation of the **interest of large cores**
 - Promising neutronics characteristics, even when increasing the loading in Minor Actinides
 - Safety characteristics to be refined, but with attractive features (**in particular** with respect to liquid metal)
 - Main challenges are still on the core design (in relation the **innovative fuels feasibility**) and the system (**safety approach / safety systems / power conversion**)

